



LED STRIP LIGHTING

SA W-COB WT LR Strip

Features

- Chips-on-board design, dot free even without any profiles
- **Can be run in up to 20M length from one driver**
- Can finish one end of the wire without voltage drop
- **Cutting length - every 50mm**
- Outstanding dissipation of heat
- Constant Current
- IP67 rated - **Clear silicone cover**
- Flexible with 3M I VHB back tape, easy for installation
- 5 years warranty

Specification

Item Code	Colour	CCT(K)	Luminous Flux(lm)	Efficiency(lm/W)
SA 9DSE2	Warm White	3000K	630	90
SA 9DSE2-A	Warm White	4000K	665	95
SA 9DSE1	Pure White	6500K	700	100
SA 9DSE3	RED	-	86	12
SA 9DSE4	BLUE	-	98	14

Technical Characteristics

Power Consumption	7W/M
Voltage	DC24V
Current Dissipation	0.29A
Efficiency	up to 100lm/W
CRI (Ra)	80+
IP Rating	IP67
Cutable Length	50mm

IP Rating

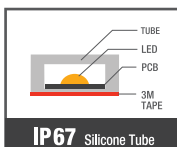

Certification



Temperature Ranges

Operating temperature	-20~40°
Storage temperature	-20~45°

Warranty

Warranty	5 Years
----------	---------

Physical Characteristics

Dimensions : mm (W*H*M)	12*6.5*20000
Weight	1675g

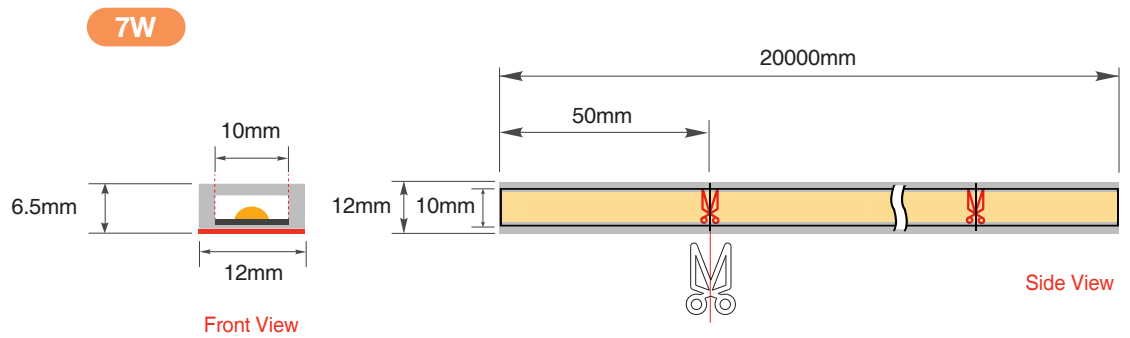

Max in series 20 Metre

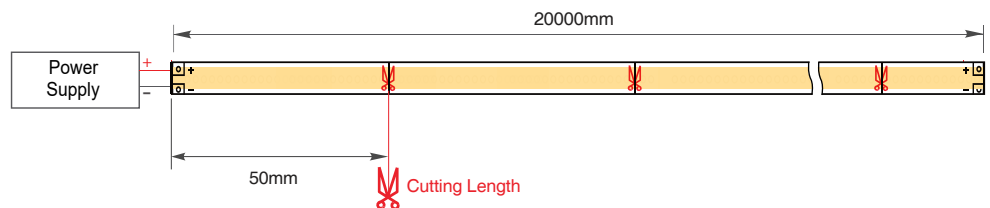

DO YOU NEED LED LAYOUTS?

Send your artwork files to our LED expert team, we'll provide an LED layout shortly.

What's included?

- Recommend the best modules and quantity.
- Advise on the optimal module pitch for even brightness.
- Suggest the best power supplies and quantity.

LED MASTER

B2B Believe

LED STRIP ACCESSORIES
COB STRIP





W-COB STRIP LIGHT (Required)

Model	Item Code	Features	Dimension(mm)	
End Cap	WL 4L	Silicone End cap without Hole_12mm (5pack)	W:13.5 L:10 H:5	
Strip Connector	SA 9811	2pin connector_Strip to Strip for 8mm (10pack)	W:8 L:12 H:4	
Strip Connector	SA 9821	2pin connector_Wire One End for 8mm (10pack)	W:8 L:16.5 H:4	
Strip Connector	SA 9831	2pin connector_Wire Both Ends for 8mm (10pack)	W:8 L:16.5 H:4	
Strip Connector	SA 9841	Corner connector_Strip to Strip for 8mm (10pack)	W:8 L:12 H:4	
Strip Connector	SA 9812	2pin connector_Strip to Strip for 10mm (10pack)	W:10 L:12 H:4	
Strip Connector	SA 9822	2pin connector_Wire One End for 10mm (10pack)	W:10 L:16.5 H:4	
Strip Connector	SA 9832	2pin connector_Wire Both Ends for 10mm (10pack)	W:10 L:16.5 H:4	
Strip Connector	SA 9842	Corner connector_Strip to Strip for 10mm (10pack)	W:10 L:12 H:4	

Dim Controller (Required)

Model	Item Code	Features	Dimension(mm)	
Dim Controller	SA 116	LT-M1+M3-3A LED Dim Controller including remote controller with battery	Controller W:30 L:135 H:20 Remote W:60 L:104 H:9	
Dim Controller	SA 111	LT-311RF LED Dim Controller including remote controller with battery	Controller W:40 L:211 H:30 Remote W:50 L:108 H:15	

***All Strip**

Model	Item Code	Features	Diemension(mm)	
Mount Clip Sets	SA 9911	Silicone Mounting Clip Sets for Outdoor (5Sets/Pack) (1Set: 5mounting clips, 1endcap and 6screws)	W:60 L:85 H:20	
WAGO connector	SA 926-J	2 WAGO Connectors 1 Jar (100ea)	W:13.2 L:18.8 H:8.4	
LED Wire	SA 917	LED Wire UL 22AWG Red&White (50M/Roll)	-	
*This is the product we recommend, but you can discover more Connectors & LED wires on our website.				
Jump Wire	SA 95D1	Welding Jump Wire_50mm (100pcs)	W:50 L:55 H:60	
Jump Wire	SA 95D2	Welding Jump Wire_100mm (100pcs)	W:100 L:55 H:60	
Jump Wire	SA 95D3	Welding Jump Wire_150mm (100pcs)	W:150 L:55 H:60	